

PATROL- 101PET

WEATHERPROOF CURTAIN PIR & MW DETECTOR FOR OUTDOOR USE

«WITH PIR SENSOR HEATER»

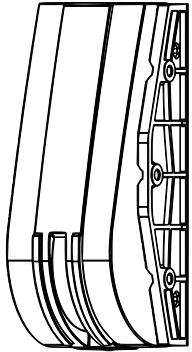

VER.2

GSN Electronic Company Ltd.

1

PATROL-101PET combined detector designed for use in open areas and low-temperature environments up to **- 40°C**.

PATROL-101PET creates a narrow protective curtain allowing free movement within the protected area without triggering the alarm.

PATROL-101PET with anti-mask technology, to detect all types of masking attempts.

PATROL-101PET provides pet immune detection up to 30kg.

2

FEATURES

- DUAL TECHNOLOGY PIR & MW
- LOW-TEMPERATURE ENVIRONMENTS UP TO **- 40°C**.
- QUAD ELEMENT PYRO SENSOR
- SHOCK SENSOR
- ANTI-MASK PROTECTION
- DOPPLER PULSE-COUNT SELECTION (1-5)
- INDIVIDUAL PIR / MW/ ANTI-MASK SENSITIVITY ADJUSTMENT
- IMMUNE TO PETS UP TO 30KG
- AUTOMATIC TEMPERATURE COMPENSATION
- VISIBLE LIGHT DISTURBANCE PROTECTION
- DOUBLE RF/EMI PROTECTION
- WEATHERPROOF HOUSING

3

DETECTOR INSTALLATION MANUAL

1. Run the installation wire through the bracket-wiring hole.
2. Mount bracket onto the wall and affix with screws, using the knockouts.

Corner installation Wall installation

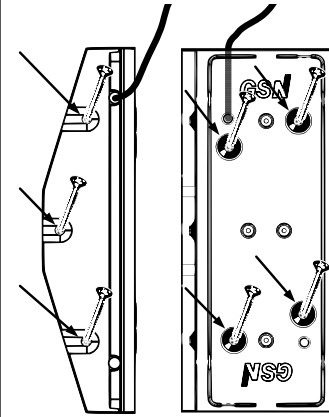

4

3. Run the installation wire through detector back cover.
4. Mount back cover of the detector to the bracket using four screws.
5. Insert the PCB and connect wires according to the schematic.
6. Close front cover and affix with screw.

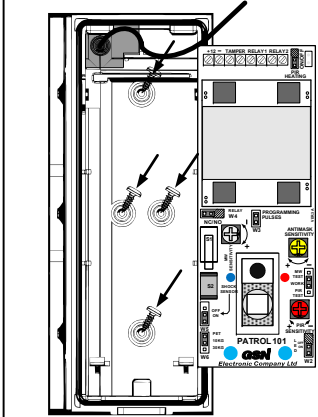

5

TERMINAL BLOCK CONNECTION

+12V- TAMPER RELAY 1 RELAY 2



Terminals “+12V-” – for connection to the power supply of the control unit.

Terminals “Tamper” – for connection to a 24-hour normally closed protective zone in the control unit.

Terminals “Relay 1” – PIR detector relay output.

Terminals “Relay 2” – anti-mask relay output.

IMPORTANT!

When connecting the heater, take into consideration voltage drop and power loss in cables.

6

PATROL-101PET MOUNTING OPTIONS

Detector can be installed vertically (see illustration). Recommended installation height is **2.5m**. Maximum installation height is **5m**.

* For installation over **3.5m**, mount the detector at an angle of **20 degrees**.

NOTE! Avoid installing detector where direct sunlight can enter the pyro sensor.

7

DETECTION AREA

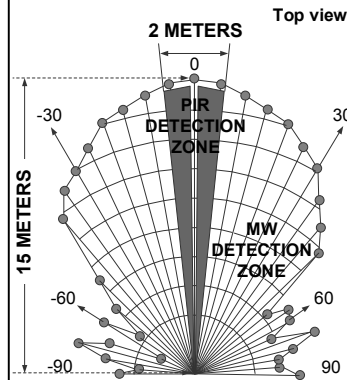

8

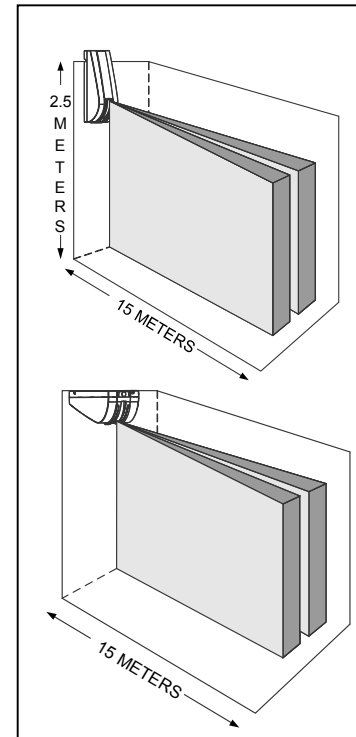

9

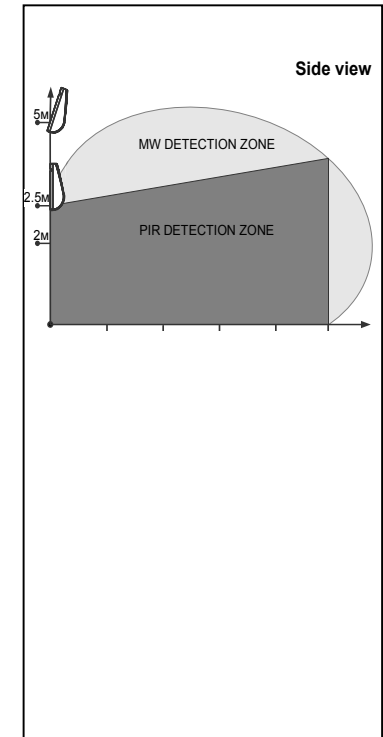

10

SHOCK SENSOR

PATROL-101PET includes a shock sensor that detects external attack. Any physical impact or attempt to separate the detector from the wall will trigger an alarm signal to the control panel through the terminal «TAMPER».

Jumper W5 enables/disables the shock sensor.

- Jumper W5 On - Shock Sensor activated.
- Jumper W5 OFF - Shock Sensor disabled.

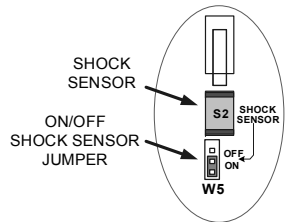

11

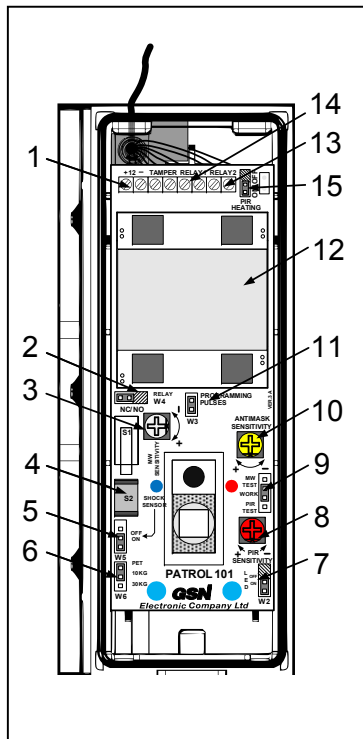

12

1. POWER SUPPLY CONNECTION
2. JUMPER TO SELECT NC/NO
3. MW SENSITIVITY ADJUSTMENT
4. SHOCK SENSOR
5. ON/OFF SHOCK SENSOR JUMPER
6. ANIMAL WEIGHT JUMPER
7. ON/OFF LED JUMPER
8. PIR SENSITIVITY ADJUSTMENT
9. OPERATING MODE SETTING
10. ANTI-MASK SENSITIVITY ADJUSTMENT
11. PULSE PROGRAMMING JUMPER
12. MW ANTENNA
13. ANTI MASK RELAY OUTPUT (RELAY 2)
14. PIR DETECTOR RELAY OUTPUT (RELAY 1)
15. PIR HEATING JUMPER

13

PIR ADJUSTMENT

1. Remove the front cover.
2. Connect the power and wait for LED to stop flashing (warm-up time 50 sec).
3. Set Jumper W1 to the "PIR TEST" position, RELAY 1 is open.
4. Replace the cover.
5. Use the "PIR SENSITIVITY" potentiometer to adjust the PIR sensitivity, moving within the protected area. The red LED should flash with each step.

14

MW ADJUSTMENT

1. Remove the front cover.
2. Set Jumper W1 to the "MW TEST" position, RELAY 1 is open.
3. Replace the cover.
4. Use the "MW SENSITIVITY" potentiometer to adjust the MW sensitivity, moving within the protected area. The blue LED should flash with each step.

15

OPERATION MODE

1. Set Jumper W1 to "WORK" position.
2. Set Jumper W6 according to animal weight.
3. Replace the cover – LED will blink.

At the same time, keep the detector field-of-view clear, until the LED stops blinking – the anti-mask function will then be activated correctly.

- Use the "ANTIMASK SENSITIVITY" potentiometer to adjust anti-mask sensitivity.
4. Affix the cover with screw.

16

CHANGING RELAY SWITCH CONNECTIONS

1. Disconnect the power.
2. Set Jumper W4 to "ON" position.
3. Restore power.

PULSE-COUNTING METHOD

Selectable pulse count 1, 2, 3, 4, 5 provides users with the option of optimizing detector sensitivity to suit the environment, thus retaining reliable performance at all times. To adjust pulse count for specific operating environments:

1. Remove Jumper W3. The blue LED blinks indicating that pulse counting has begun.
2. Replace Jumper W3 during pause between LED blinking.

17

TECHNICAL SPECIFICATIONS

Input voltage.....	9 – 16V
Current consumption:	
In standby mode:	80mA
In alarm mode:.....	120mA
Microwave frequency:....	10.525GHz
Anti-mask startup (boot) period:.....	50 ± 5sec
Adjustable mask detection:.....	0.2 – 20cm
Warm up period:.....	50 ± 5sec
Detection range:.....	15m
Detection speed range:.....	0.2 – 4 m/sec
Relay output:.....NC/NO; 60V; 100mA; 16Ω
Tamper output:.....NC; 60V; 100mA; 16Ω
Anti-mask Relay output:.....NC/NO; 60V; 100mA; 16Ω

18

Anti-mask alarm activation delay:.....	40-60sec
Alarm period:.....	3sec
Reset time:.....	5±1sec
Pulse counting:.....	1–5
Installation height:.....	2.5–5m
Light immunity:.....no less than 30000 lux
Operating temperature range:.....	– 40°C +60°C
Storage temperature range:.....	– 60°C +80°C
Protection rating.....	IP65
RFI immunity: 30V/m at a frequency range 30MHz-2GHz	
EMI immunity.....	50,000V
Dimensions:.....55mm x 49mm x 153mm
Weight:.....	270gr.

19

WARRANTY:

GSN Electronic Company Ltd. warrants the product to be free from defects in materials and workmanship under condition of observance of service regulations and to be repaired or replaced under absence of mechanical damages for a limited period of five years from the date of sale.

20